



# Manual - EV Charging Station NS

# Table of Contents

|  |           |
|--|-----------|
| <b>1. Safety Instructions</b> .....  | <b>1</b>  |
| <b>2. Description and features</b> .....   | <b>2</b>  |
| 2.1. Description .....   | 2         |
| 2.2. Features .....  | 2         |
| 2.3. What's in the box? .....  | 4         |
| <b>3. Installation</b> .....   | <b>5</b>  |
| <b>4. System example</b> .....   | <b>7</b>  |
| <b>5. Setup, configuration &amp; operation</b> .....   | <b>8</b>  |
| 5.1. First use setup via VictronConnect .....  | 8         |
| 5.2. VictronConnect setup, configuration and operation .....   | 9         |
| 5.2.1. Setup .....   | 9         |
| 5.2.2. Overview page .....   | 10        |
| 5.2.3. Settings page .....   | 10        |
| 5.2.4. Product info page .....   | 11        |
| 5.2.5. Network Settings .....  | 12        |
| 5.2.6. General Settings .....  | 13        |
| 5.2.7. Scheduler .....   | 17        |
| 5.2.8. Light Ring .....  | 18        |
| 5.2.9. Access .....  | 18        |
| 5.2.10. Reset to defaults .....  | 19        |
| 5.3. GX device setup, configuration and operation .....  | 20        |
| 5.3.1. Modbus TCP activation .....   | 20        |
| 5.3.2. Setup menu and options .....  | 21        |
| 5.3.3. Overview and device menu .....  | 21        |
| 5.4. Firmware updates .....  | 21        |
| 5.5. Reset to factory defaults and password recovery .....   | 23        |
| 5.6. Maintenance .....   | 24        |
| 5.7. First setup .....   | 24        |
| <b>6. Troubleshooting</b> .....  | <b>25</b> |
| 6.1. CP Line Calibration .....   | 25        |
| 6.2. Frequently asked questions .....  | 26        |
| 6.2.1. Q1: How do I prevent the charging station from being used by unauthorised persons? .....                        | 26        |
| 6.2.2. Q2: Does the EV Charging Station have RFID? .....   | 26        |
| 6.2.3. Q3: The light ring is annoying my neighbours during night, how can I disable the light ring? .....              | 26        |
| 6.2.4. Q4: Why isn't my car recognized when I connect the charging cable? .....  | 26        |
| 6.2.5. Q5: Why does my EV Charging Station show up on multiple GX devices? .....                                       | 26        |
| 6.2.6. Q6: How much PV power do I need at least to charge the EV in automatic mode? .....                              | 26        |
| 6.2.7. Q7: Is it possible to operate multiple EV Charging Stations in one system? .....                                | 26        |
| 6.2.8. Q8: The EV is fully charged, but the EVCS still alternates between start charging and stop charging, why? ..... | 26        |
| 6.2.9. Q9: I keep getting a W-104 GX communication warning! What is the reason for this? .....                         | 26        |
| 6.2.10. Q10: Is a GX device in the system absolutely necessary? .....  | 27        |
| 6.2.11. Q11: I would like to control the EVCS via Modbus TCP. Is this possible and if so, how? .....                   | 27        |
| 6.3. EVCS Notification, Warning, Alarm and Error Codes .....   | 27        |
| <b>7. Technical specification</b> .....  | <b>30</b> |
| 7.1. Dimensions .....  | 31        |
| 7.2. Drilling template .....   | 32        |
| <b>8. Appendix</b> .....   | <b>33</b> |
| 8.1. First use setup and configuration via WiFi AP and web interface .....   | 33        |
| 8.1.1. First use setup via WiFi access point .....   | 33        |
| 8.1.2. EV Charging Station setup web interface .....   | 37        |
| 8.1.3. The main page .....   | 40        |
| 8.1.4. Networks menu .....   | 41        |
| 8.1.5. Access menu .....   | 42        |

8.2. External control of grid-relevant power (§14a EnWG - Germany) ..... 42

# 1. Safety Instructions

Please read the safety instructions below before using the EV Charging Station NS to avoid risks of fire, electric shocks, personal injuries or equipment damage.

Installation and adjustments must be made by qualified personnel only. To reduce the risk of electric shock, do not perform any servicing other than that specified in the operating instructions unless you are qualified to do so.

For electrical work, follow the local national wiring standard, regulation and these installation instructions. Connection to the mains supply must be in accordance with the national regulations for electrical installations.

This product is designed and tested in accordance with international standards. The equipment should be used for its designated application only and in accordance with the specified operating parameters.

## Warnings and cautions:



- Never install near fire sources, explosive materials, combustibles or other flammable sources. Never use it at places where gas or other chemical explosions could occur.
- It must be connected all the times to the ground, otherwise it will not allow charging.
- Turn off the EV Charging Station NS power before installing or performing operations to it.
- Make sure children are supervised if using the equipment.
- Do not put fingers or insert objects or sharp metallic objects into the terminals. Do not insert objects into any other parts of the EV Charging Station NS.
- Do not use the device if the power cord or EV cable is broken, shows any signs of damage or does not function properly.
- Do not use the EV Charging Station NS if it is broken, defective, cracked, damaged or does not function properly.
- Do not apply strong force on the equipment, to prevent crashes and deterioration.
- Do not use any sharp objects to damage the product.
- Do not service the equipment by yourself, do not open, disassemble or make any modifications to it. Contact your Victron Energy Distributor.
- Do not touch any live electrical parts.
- Do not place the EV cables connected to the charging station in water.
- Make sure ground connection is properly done to prevent equipment damage.
- Transport the device with care in its original package to avoid damage to it and its components.
- Store in a dry environment, at temperatures between  $-20\text{ }^{\circ}\text{C}$  to  $60\text{ }^{\circ}\text{C}$ .
- Do not operate at temperatures outside the operating range of  $-25\text{ }^{\circ}\text{C}$  to  $50\text{ }^{\circ}\text{C}$ .
- As the EV Charging Station NS can affect the functioning of certain medical electronic implants, check any potential side effects with your electronic device manufacturer before using the device.

## 2. Description and features

### 2.1. Description

The EV Charging Station NS with its three-phase and single-phase charging capabilities integrates seamlessly into the Victron environment with its [GX device](#) connection via WiFi and enables easy operation and control via Bluetooth and the [VictronConnect App](#). It delivers a maximum of 22kW AC in three-phase or 7.3kW in single-phase mode.

Not only does this EV charging station fully integrate with a Victron Energy GX device and VRM, if you have solar, it can also be set up to allow excess energy from the sun to directly charge your vehicle once certain parameters are met. See the [Setup, configuration & operation \[8\]](#) chapter for details.

The tough plastic enclosure is designed to withstand harsh weather and can be mounted inside or outside. In addition to the default blue device front, a black and a white front are also available.

A programmable RGB light ring around the charging port (type 2 EV charging plug) allows for quick determination of the device state and can be programmed from the integrated web interface to display different light effects based on the current state (disconnected, charging, charged etc.).

### 2.2. Features

Three operation modes:

#### 1. Automatic mode to ensure maximum PV system efficiency

Thanks to the seamless integration of the EV Charging Station NS with the rest of the Victron installation, it detects when there is a surplus of solar power and uses this exclusively to charge the vehicle or, if desired, adds energy from the grid to cover the minimum power requirement, for example, if there is not enough surplus solar power. Note that this mode requires a GX device in your system and communication between GX device and EVCS enabled. For details, see chapter [VictronConnect setup, configuration and operation \[9\]](#) and [EV Charging Station setup web interface \[37\]](#).

Instead of losing surplus energy when the batteries are full and, for example, feeding it back into the grid at a lower price, the energy is stored in the EV battery.

- Seamless integration into the Victron installation
- Detects when excess power is available and uses only that to charge the vehicle before exporting it to the grid
- Ensures maximum PV efficiency
- Battery-powered algorithm (used by default) for automatic mode ensures that automatic mode works even when off-grid

#### How does it work?

The EVCS will automatically start charging when the vehicle is connected and the following conditions are met:

1. The current state of charge is above the 'Start charging at backup battery SoC (%)' value.
2. There is enough excess solar power available, with excess solar power calculated as follows:
  - $\text{Excess solar power} = \text{Total PV production} - \text{AC loads (without car consumption)} = 1380\text{W} (230\text{V} \times 6\text{A})$

In the example above, the Min. charge current (from 6A) value has been set to 6A. The required excess solar power increases accordingly if a higher value is set for the Min. charge current (from 6A). Please see the chapter [VictronConnect setup, configuration and operation \[9\]](#) for details on both parameters.
3. Or, if there is not enough excess solar power available to meet the minimum charge current requirement as per 2., it is possible to enable the 'Allow low excess solar power for auto mode' option. This option supplements the required power with additional power from the grid to meet the minimum current requirement. See chapter [EV Charging Station setup web interface \[37\]](#) for details.

#### 2. Manual mode to configure output current

Manual mode allows configurable output current between 6-32A.

The charging power is controlled in several ways:

- By using the web interface via a web browser
- From a GX device touch screen like the [GX Touch 50 & GX Touch 70](#).
- From the Remote Console

- By using the Controls on the Dashboard of the VRM Portal (requires a GX device)
- Via Bluetooth and the VictronConnect App

It allows charging to be started or stopped manually when an EV is connected to the charging station, regardless of PV production.

### 3. Scheduled mode to allow automatic charging at custom time intervals

The Scheduler allows charging at different time intervals, for example at certain times during the night when grid energy is cheaper.

In addition to the start and end time, various parameters such as charging current and interval can be defined.

The EVCS will then start charging according to the scheduler settings.

### WiFi Communication WiFi 802.11 b/g/n for configuration, control and monitoring

The internal WiFi module can be configured in Access Point mode or Station mode, for first setup, control and monitoring.

### Bluetooth communication via VictronConnect

Integrated Bluetooth capability enables easy monitoring and control of the EV Charging Station NS via [VictronConnect](#) from any mobile device such as an iPhone, iPad or Android phone.

For more details see the [VictronConnect setup, configuration and operation \[9\]](#) chapter.

### Integration with GX devices

Control and monitor the EV Charging Station NS from a GX device such as the [Cerbo GX](#) and the Remote Console.

For more details see the [GX device setup, configuration and operation \[20\]](#) chapter.

### Integration with VRM

Several options are available in the VRM Portal:

- Real-time reports
- Custom reports for configurable time periods
- Advanced functions such as remote firmware updates
- Change mode and charge current via Dashboard Controls on the VRM Portal and start/stop charging
- Access the EVCS web interface from VRM via a proxy link by clicking 'Control Panel' in the Device list

Control and monitoring are also possible via VRM App (download from the App Store or Google Play) and [VRM App Widgets](#) directly from the home screen of a mobile device.

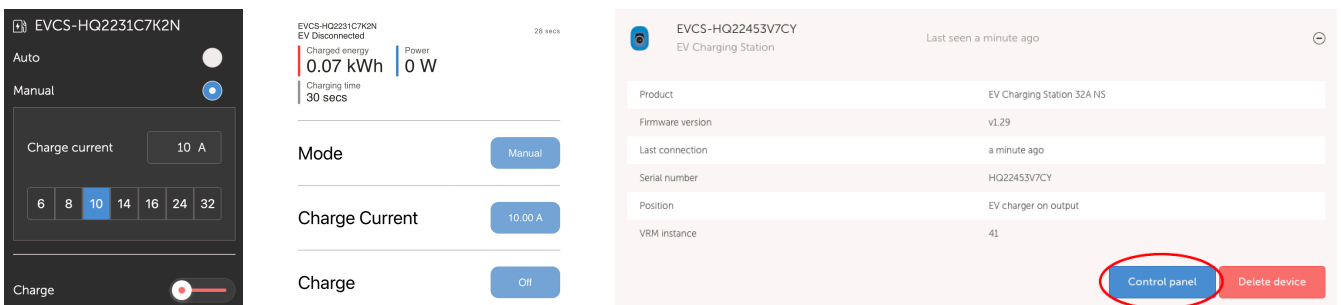

For detailed information, see the [VRM Portal documentation](#).

### Light Ring for fast viewing the device state

It also has a fully programmable RGB light ring around the charging port, which can be used to quickly determine the status of the device even from a distance. It can be programmed via the web interface to display different light effects depending on the current state (disconnected, charged, loaded, etc.).

## 2.3. What's in the box?

- EV Charging Station NS
- Mounting plate
- 28mm nylon cable gland for power cables up to 19mm in diameter
- Type 2 cable plug holder dummy socket
- Rubber plug

## 3. Installation

This product may only be installed by qualified personnel (licensed electrician).

It is suitable for wall mounting or pole mounting (vertical surface). In all cases, the surface should be solid and flat.

### Precautionary measures



- Ensure that the AC input is protected by a fuse or magnetic circuit breaker rated at 40A or less. The cable cross-section must be sized accordingly. If the AC input supply is rated at a lower value, the fuse or magnetic circuit breaker should be sized accordingly.
- An external RCD is required.
- We recommend using an RCD type B protected supply (check local legislation) . Make sure that the RCD corresponds to the maximum power used, i.e. use a 40A RCD type B if you charge mostly with 22kW or correspondingly smaller if you charge with less power
- Recommended cable cross-section is 6mm<sup>2</sup> / AWG 10.
- Inside the device is a sticker with the model, serial number, WiFi password and, depending on the date of manufacture, the unique Bluetooth pairing code. Note the password and pairing code on the internal label for future reference. This initial password can be used for both logging in on the web page but also for WiFi connection.
- The tightening force of the screws on the backing plate should be 1-1.2 Nm.
- The mounting surface should be solid and flat.
- Make sure you always have the latest version of this manual, which is updated regularly and available on the [EV Charging Station](#) website.

### Installation steps:

1. Decide whether the power cable should be routed from the bottom or from the rear into the charging station.
2. Remove the blue cover (2 screws at the bottom) from the charging station.
3. Mark the wall where it should be mounted using the supplied wall plate or the [drilling template \[32\]](#) in the appendix.
4. Drill 3 holes with wall plugs ready for installation, see the drilling template in the appendix.
5. Measure a suitable location and drill through the wall for the cable (when main supply cable comes from inside the building). Note that if the cable is fed into the charging station from the rear instead of the bottom, the hole will match the drilling template.
6. Depending on whether the cable is routed from below or from behind, knock out the appropriate hole for the nylon gland with a screwdriver or use a 28mm drill and insert the nylon gland. If the cable is routed from the rear, attach the supplied rubber plug instead and pierce a hole slightly smaller than the power cable into it to make a watertight connection.
7. Label each individual cable and pass it through the wall, the nylon gland (or the rubber plug), the grommet and into the charging station.
8. Terminate the cable ends with ferrules and connect to the relevant points.
9. If this is a single-phase installation, use L1, neutral and earth connections.
10. Tighten the nylon gland if installed from the bottom.
11. Hang the device over the wall plate and fix it with the two screws from inside the device.
12. Attach the blue cover and fix it with the 2 screws from the bottom side. Make sure it is firmly seated.

Watch this video for an installation example:

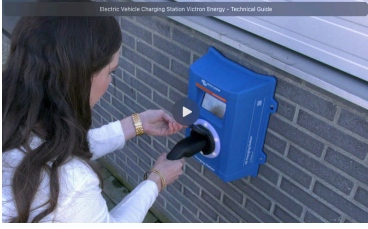

## 4. System example

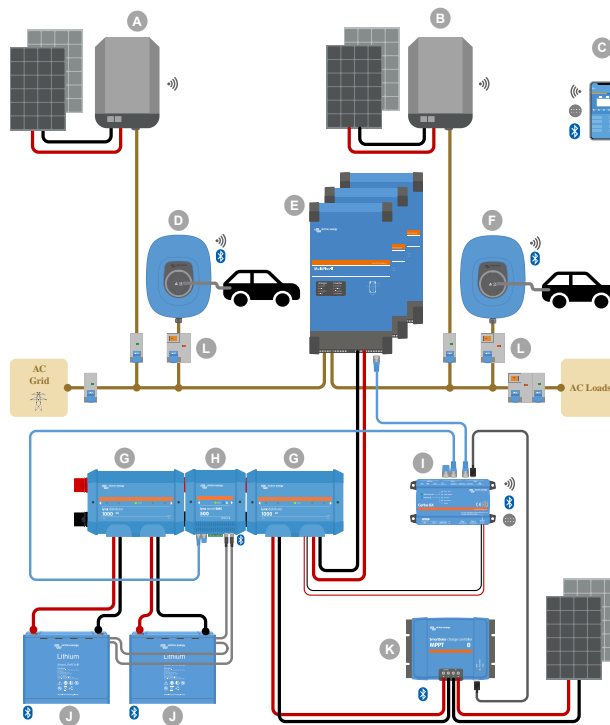

This system displays all available options, specifically:

- All solar types: AC PV on AC input, AC PV on AC output and DC PV
- EV Charging Station NS on AC input or AC output of the inverter/charger
- Single-phase or three-phase

| Key | Description  |
|-----|--|
| A   | Grid-feed PV Inverter connected to the AC input of the <a href="#">inverter/charger</a>  |
| B   | Grid-feed PV Inverter connected to the AC output of the <a href="#">inverter/charger</a>   |
| C   | Setup, control and monitoring via WiFi or Bluetooth and <a href="#">VictronConnect</a> , web interface or <a href="#">VRM portal</a> (setup only via WiFi or Bluetooth)  |
| D   | EV Charging Station NS: Connected to the AC input of the <a href="#">inverter/charger</a>  |
| E   | For single-phase systems: a single inverter/charger or inverters/chargers connected in parallel<br>For three-phase systems: three inverter/chargers connected in 3-phase or multiple strings of paralleled units connected in 3-phase      |
| F   | EV Charging Station NS: Connected to the AC output of the inverter/charger   |
| G   | <a href="#">Lynx Distributor</a> : On the battery side and on the system side, containing a positive and negative bus bar and all DC fuses   |
| H   | <a href="#">Lynx Smart BMS</a> : Monitors and controls (with built-in battery monitor and contactor) the Victron Smart Lithium batteries and Lynx Distributor fuses  |
| I   | <a href="#">Cerbo GX</a> : Serves as a control and communication center and enables remote control and monitoring via the <a href="#">VRM portal</a> and/or the <a href="#">VRM App Widgets</a> , accessible directly from a mobile device |
| J   | <a href="#">Victron Lithium Battery Smart</a> : Available in 12.8V & 25.6V and different capacities. A maximum energy storage capacity of 102kWh can be achieved by combining batteries in both series and parallel configurations         |
| K   | <a href="#">Solar Charge Controller</a> : A variety of MPPT solar charge controllers are available with voltage ranges from 75V to 450V, allowing for topping up of energy storage and storage of surplus energy in the vehicle's battery  |
| L   | Dedicated RCD type B (40A for charging at 22kW) on the EV charger input  |

## 5. Setup, configuration & operation

### 5.1. First use setup via VictronConnect

The initial setup is required when the EVCS is new and has yet to be configured or after it has been reset to factory defaults.

#### Preparation

1. Open VictronConnect and find the entry for your EVCS (EVCS-HQXXXXXXXXXX).
- 2.
3. If the pairing was successful, the status page would appear; ignore the warning for now (using the EVCS is not yet possible) and tap the cog wheel icon in the upper right to open the Settings page so that the initial setup can be performed.

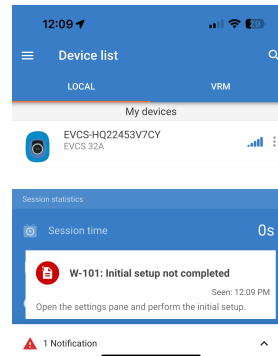

#### Step 1 of 3: Configure WiFi access

One of the following parameters **must** be changed to complete the first setup and start using the EV:

- Either confirm the WiFi mode AP (the EVCS provides its own access point) - all necessary parameters are already pre-filled. The AP passphrase corresponds to the password as stated on the sticker inside the EVCS.
- Or choose Station mode to connect the EVCS to your local network/router. If you already know the network name (SSID), you can enter it manually. Alternatively, hit SCAN to find nearby networks, select your desired network, and enter the access password.

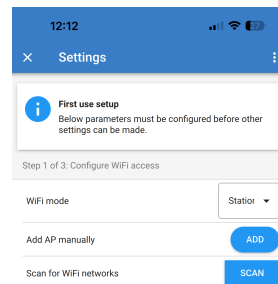
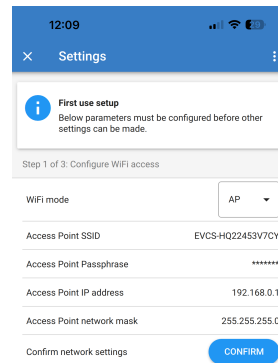

#### Step 2 of 3: Change web access credentials

This step is necessary to ensure secure access to the web interface. The default username is "admin". The default password corresponds to the one on the sticker inside the EVCS. We recommend setting up your own password and username.

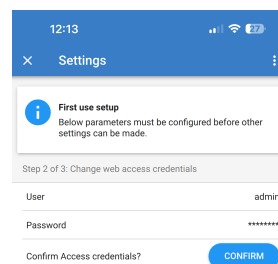

**Step 3 of 3: Set the maximum charging current**

Set the maximum charging current with which the EVCS is allowed to charge (range: 6A - 32A).

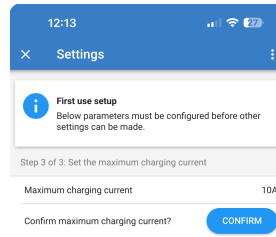
**5.2. VictronConnect setup, configuration and operation****5.2.1. Setup**

The following steps are necessary to successfully connect to the EV Charging Station NS via Bluetooth and VictronConnect:

1. Make sure Bluetooth is enabled in your EVCS.



In case Bluetooth is disabled, see the [Networks menu \[41\]](#) chapter for details on enabling Bluetooth.

2. Download and install the VictronConnect app from the App Store or Google Play.
3. Open VictronConnect and scroll through the list of devices for the EVCS.
4. Tap on it to launch the pairing dialog. Enter the pairing code which is the unique number on the sticker inside the housing.
5. If the pairing was successful, the EVCS overview page is displayed.

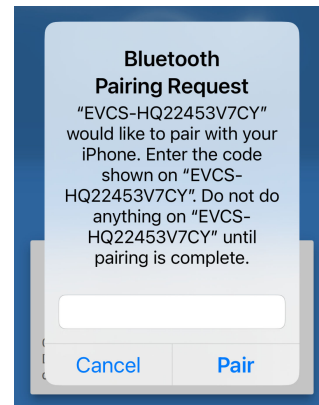

### 5.2.2. Overview page

The overview page provides information about the charging state, controls to start/stop charging or changing the charging mode and charging current. Furthermore, the actual charging values and session statistics can be monitored.

#### Controls:

- **Start/Stop:** Start or stop charging when in manual mode.  
Note that after pressing the stop button, first the charging current is reduced to a minimum and only then the contactor opens (with a delay of 2 seconds).
- **Charging mode:** Change the charging mode to manual, auto or scheduled.
- **Charging current:** Adjust the charging current (range: 6-32A, depending on the Minimum and Maximum charging current set on the General Settings page or on the web interface).

#### Actual charging values:

- **Current:** The charging current.
- **Power:** Charging power. With a multi-phase supply, all phases are combined.

#### Session statistics:

- **Session time:** The time of the current charging session.
- **Session energy:** Total energy charged in this session.
- **Session cost:** The session cost (when charged from grid) depending on the energy price per kWh set in the EVCS settings, see the [EV Charging Station setup \[37\]](#) chapter.
- **Session saved cost:** Saved cost based on energy charged from PV and depending on the energy price per kWh set in the EVCS settings.
- **Total Energy:** The total energy charged since initial installation.

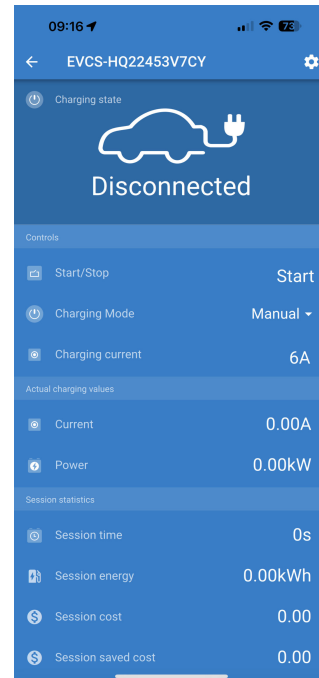

### 5.2.3. Settings page

The Settings menu is accessible by pressing the cog wheel from the top right of the Overview page.

The following menu options are available:

- **Network:** Change the network settings.
- **General:** Adjust the charger settings.
- **Scheduler:** Set up charging schedules.
- **Light Ring:** Configure the behaviour of the light ring.
- **Access:** Specify web access credentials.

These settings are similar to those explained in the [Networks menu \[41\]](#) and [EV Charging Station setup \[37\]](#) chapter, with the exception that it is possible to trigger a system reboot if required.

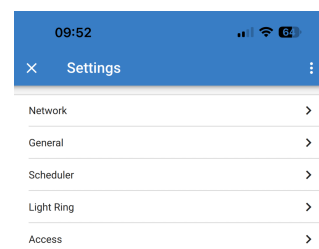

Tap the three vertical dots in the top right corner of the settings page to perform the following actions:

- **Import settings from file:** Import previously saved settings from a file in the settings library.
- **Save settings to file:** Save the current settings to a file which will be stored in the settings library. This file can be used as a backup to restore settings on this EV Charging Station NS or to easily apply the same settings to another one.
- **Share settings:** Share the settings file via email or other social apps which may be in use on the Android or iOS device for example.
- **Product info:** Displays the EV Charging Station NS model number and serial number. There is also a switch to enable or disable Bluetooth. See the [Product info](#) section for more information.
- **Reset to defaults:** Reset all settings to the factory defaults. This will mean that any customised settings will be lost and setup will need to be performed again or imported from a previously saved settings file.

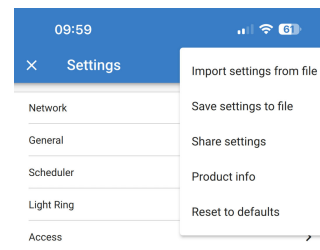

#### 5.2.4. Product info page

To get to the Product info page, tap the 3 vertical dots icon from the Settings page.

- **Product:** Shows the product name and the model number.
- **Serial number:** Shows the serial number of the EV Charging Station NS.
- **Pin code:** Pin code is hidden but it can be changed using the change button to the right.
- **Custom name:** Change the friendly name of the EV Charging Station NS.
- **Firmware:** Displays the current firmware version running on the EV Charging Station NS.
- **Bluetooth:** Enable or disable the Bluetooth functionality of the EV Charging Station NS.

More about how to assign your own name to your EV Charging Station NS and how to deactivate and reactivate Bluetooth, please refer to the [VictronConnect App manual](#).



Note that if you disable Bluetooth via VictronConnect, it will have to be re-enabled via the web interface [Networks menu \[41\]](#) or by using the [Reset to factory defaults \[23\]](#) feature, either via the web interface or the DEF button procedure. For older devices that have Bluetooth disabled from the factory, use the web interface's network menu to enable Bluetooth.

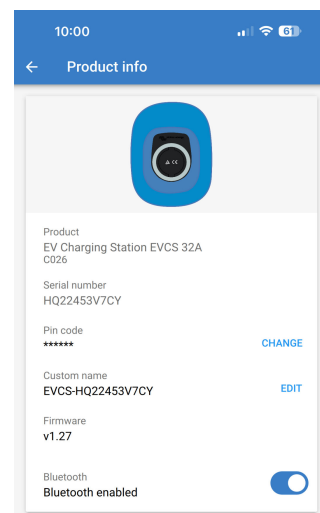

## 5.2.5. Network Settings

The Network information section shows:

- **Network current status:** Shows the current status of the network.
- **Connected to:** Displays the name of the WiFi network that the EV Charging Station NS is connected to.
- **Local IP address:** Displays the LAN IP address of the EV Charging Station NS.

The WiFi section allows configuration of the WiFi settings for the EV Charging Station NS.

- **Mode:** Allows the choice of local WiFi connection or if the EV Charging Station NS should create a WiFi Access Point. The EV Charging Station NS should usually only be set up to act as an Access Point if there are no other WiFi networks available.



The EVCS local WiFi connection (STA) mode is designed to operate within a network environment that uses certified, standards-compliant networking equipment. Ensure that the WiFi access point or router used in your installation meets applicable regulatory requirements and is RED-compliant, so the EVCS remains protected and performs reliably within a properly managed network.

- **IP Configuration:** Option to allow automatic (DHCP) IP address allocation or manual fixed IP address configuration. Automatic IP configuration is the recommended option. The manual option is only intended for advanced network configurations or by instruction from the network's administrator.
- **Scan period:** To allow periodic automatic WiFi network scanning and if so, to define the period of time between automatic scans.
- **Rssi Threshold:** Sets the minimum signal strength that discovered WiFi networks should have before being added to the list.

The Access point list section shows discovered local WiFi networks or allows for a WiFi network to be added manually.

The currently connected Access Point name is shown here in green along with "FORGET" and "DISABLE" buttons.

- **Add AP manually:** Provides the option to add a WiFi network manually. This may be used in circumstances where the required network's SSID is hidden and doesn't show in the list of discovered networks.
- **Scan for WiFi networks:** Tap the "SCAN" button to immediately scan for available WiFi networks nearby.

A list of all available WiFi networks will begin to appear as they are discovered. The list includes the Access Point name, its security status shown with a padlock symbol. The signal strength received by the EV Charging Station is displayed with the WiFi symbol to the right.

Tap the "ADD" button beside the network that you wish to connect to. You'll be asked to enter the password for the selected network if applicable.

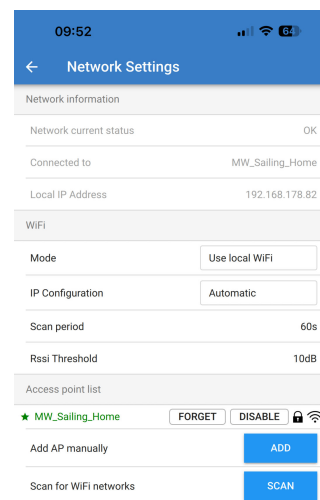

## 5.2.6. General Settings

The General settings page lists the options for the general configuration of the EV Charging Station NS.

Charging settings section has the following options:

- **EV Charger position:** This option selects where in the system the EV Charging Station NS is wired. For example, the EV Charging Station NS could be wired on the AC Input side or the AC Output side of a MultiPlus.
- **EV Charger autostart:** This option defines whether or not the EV charger will begin charging automatically when the EV charging cable is connected to the vehicle.
- **Contactor active when charged:** When the EV is charged the contactor can be set to remain closed or to open which will fully disconnect the EV from the supply.
- **Maximum charging current:** The maximum charging current that the EV Charging Station NS will supply to the EV in any event. The configurable range is 6A to 32A.
- **Minimum charging current:** The minimum charging current that should be supplied to the EV unless it is charged to the desired level. The configurable range is 6A to 32A.
- **CP Calibration:** Allows calibration of the CP (control pilot) signal line.
- **Power calibration:** Adjust this setting to calibrate the Actual power reading.
- **Actual power:** Displays the actual combined power of all phases that the EV Charging Station NS is supplying to the EV.

Other settings section provides:

- **GX Device settings:** Select this option for communicating with a GX Device such as a Cerbo GX or Ekrano GX.
- **Modbus TCP settings:** Enable the IP address whitelist and add IP addresses to the whitelist.
- **Date & Time:** Set the time zone, date and time.
- **Energy price per kWh:** Set the price of energy imported from the grid.

Reboot EVCS:

- **System reboot:** tap the "REBOOT" button to reboot the EV Charging Station NS.

### EV Charger position

Select the position that the EV Charging Station NS is wired in the system.

If the EV Charging Station NS is wired anywhere before the Inverter / Charger then select the "Inverter AC in" option.

Alternatively, if the EV Charging Station NS is wired after the Inverter / Charger or is wired after an Inverter then choose the "Inverter AC out" option.

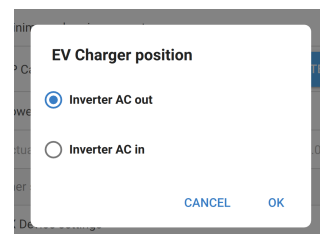
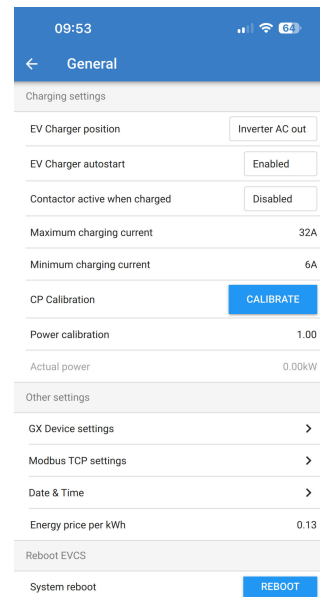

### EV Charger autostart

Choose whether or not the EV Charging Station NS starts automatically when the charging cable is connected to the EV.

Select "Enabled" to have charging start automatically when the charging cable is connected to the EV.

Select "Disabled" if you don't want charging to start automatically. In this case charging needs to be started manually by pressing the "Start" button from the Overview page. This can help to prevent unauthorised use of the EV Charging Station NS.

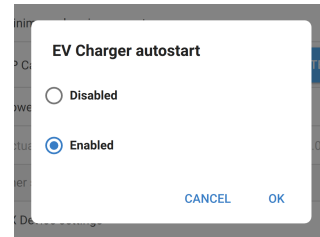

### Contactor active when charged

Choose whether or not the contactor within the EV Charging Station NS remains closed or opens when the EV is charged but the cable is still connected.

Select "Enabled" for the internal contactor to remain closed when the EV is charged. For example, this can be useful if you would like to precondition the cabin air using electricity from the charging source rather than the EV battery.

Select "Disabled" if you want the internal contactor to open when the EV is charged. This has the effect of disconnecting the EV from the supply as if the charging cable is removed.

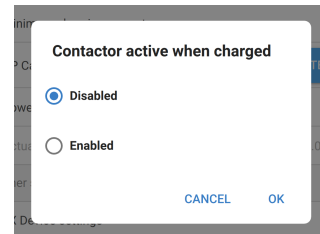

**GX device communication**

The GX device settings page is accessible from the General settings page.

- **Communication:** Enable or disable communication with a GX device in the system.
- **Start charging at backup battery SOC:** The minimum backup battery SOC before the EV Charging Station NS starts charging in Auto mode.
- **Stop charging at backup battery SOC if off grid:** When off-grid or the grid is not available, then the EV Charging Station NS will stop charging when the backup battery SOC falls below this level.
- **Allow Battery/Grid power for Auto mode:** Enable this setting to allow Auto mode to continue charging the EV at minimum current even if there is insufficient excess solar power. This helps to minimise automatic charging enable/disable cycles when in Auto mode. Note: The EV Charging Station NS cannot decide if the energy comes from the battery or grid, this is up to the inverter/charger in the system.
- **Battery/Grid power timeout:** If the above setting is enabled then this is the maximum continuous amount of time that the EV Charging Station NS will draw power from the battery or grid.

- **Overload protection:** When enabled, this setting will read the overload status of the system inverter. In the event of an overload then the EV Charging Station NS will reduce its charging current to minimum and wait about 5 seconds. If the inverter overload condition is still active then the EV Charging Station NS will stop charging. EV charging will resume a short period of time after the inverter overload condition has cleared.

If multiple overload events are detected within a certain time period the the EV Charging Station NS will reduce the charging current by 10%.

The same applies to grid-tied system where an enforced grid current limit is exceeded.

A warning will be displayed in VictronConnect or in the EV Charging Station NS if charging power is reduced or if charging is interrupted.

- **Input current limit:** This displays the enforced grid current limit which is applied to grid-tied systems.
- **IP Address:** Displays the IP address of the GX device. Tap on the "IP Address" line to change it.
- **VRM Portal ID:** Displays the VRM portal ID. Tap on the "VRM Portal ID" line to change it.

- **Check communication:** Tap the "CHECK" button to check the communication between the EV Charging Station NS and the GX device using the IP address set above.

- **Check result:** Shows if the communication check to the GX device has passed or failed.

If the communication check fails then verify that the GX IP address specified is correct or use the "DISCOVER" button to search for a local GX device as below.

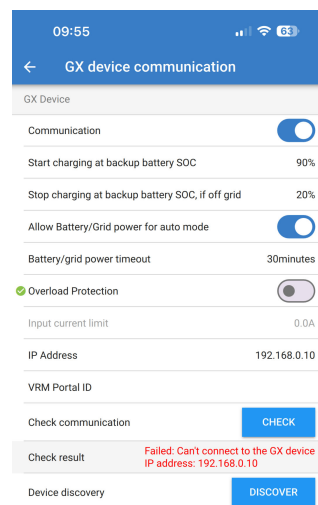
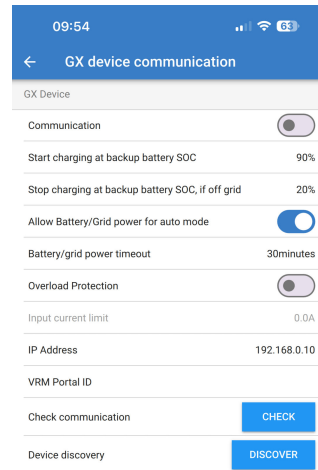

- **Device discovery:** Tap the "DISCOVER" button to allow the EV Charging Station NS to automatically discover any GX devices on the local network.
- **Discovery result:** Any GX devices which have been found by Device discovery will be listed.

Tap "ADD" to pair the desired GX device to the EV Charging Station NS. This will then become the GX device that the EV Charging Station NS communicates with and its details will be populated in the IP Address and VRM Portal ID fields.

**Modbus TCP settings**

The ModbusTCP Server settings allow enabling the IP whitelist and to add GX devices' IP addresses to be added to it.

With the whitelist enabled, only the IP addresses added to the whitelist will be able to communicate with the EV Charging Station NS.

For security reasons it is highly advisable to enable the TCP whitelist and to add only the GX devices which need to communicate with the EV Charging Station NS. This may also be a requirement from grid operators in some countries.

- **Enable IP address whitelist:** Enable or disable the IP whitelist feature.
- **Add IP to whitelist:** Tap the "ADD" button to populate the whitelist with trusted IP addresses.

**Date & Time**

- **Region:** Select your time zone region.
- **Offset:** If UTC region is selected then it will be necessary to enter the correct offset for your time zone.

**Energy price per kWh**

- Enter the price of imported electricity per kWh. This will be used to calculate the session savings.

**System reboot**

- Tap the "REBOOT" button to reboot the EV Charging Station NS. Select "YES" on the popup window to confirm reboot.

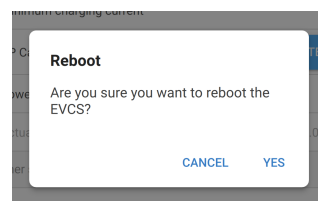
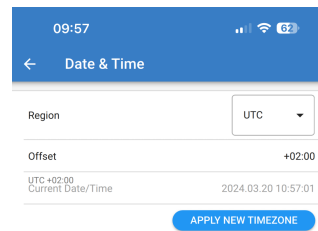
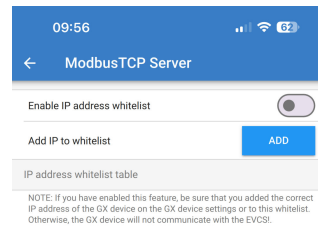
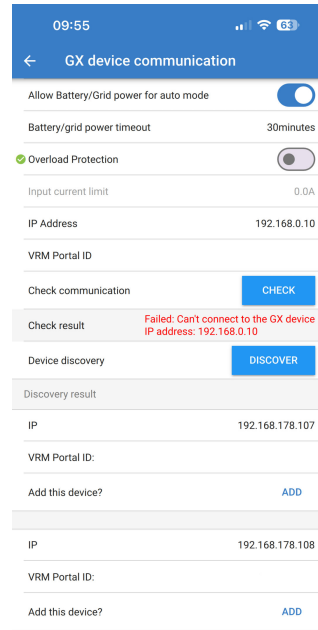

### 5.2.7. Scheduler

If the Charging Mode is set to "Scheduled" from the Overview page then the EV Charging Station NS will charge according to the schedules set in this section.

- **Add a new schedule:** Tap here to configure a new schedule.

On the Scheduled scene configuration page you can adjust the following conditions. The time conditions are expressed in 24h format.

- **Enable:** Toggle the current scene to enable or disable it.
- **Start time:** The time that you want the EV Charging Station NS to begin charging.
- **End time:** The time that you want the EV Charging Station NS to stop charging.
- **Current:** The maximum amount of current to charge the EV during this schedule.
- **Repeat:** Select the drop down menu to choose the type of repeat pattern.
  - **Daily:** The schedule will repeat every day.
  - **Mon-Fri:** The schedule repeats on week days Monday to Friday only.
  - **Weekends:** The schedule repeats on weekends Saturday and Sunday only.
  - **Custom:** A list of each day of the week is shown. Tick the days of the week that you would like this schedule scene to apply to.

Once you have set your preferences then tap the "SAVE NEW SCHEDULE" button to add it to the scheduler or "CANCEL" if you don't want to create the new schedule.

The newly created schedule will be added to the scheduler list. From here the individual schedules can be enabled or disabled, amended or deleted.

- **Status:** Shows the status of the scene. If the scene is disabled then it will not run.
- **Delete schedule:** Tap the "DELETE" button to delete the schedule, a popup box will show to confirm schedule deletion.
- **Add a new schedule:** This will be shown below the existing schedules and can be selected to create an additional schedule.

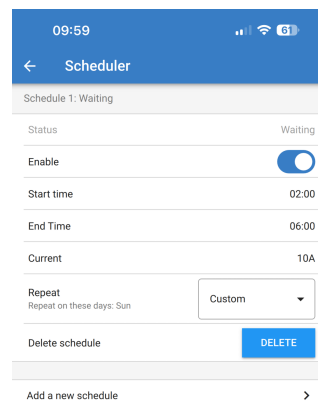
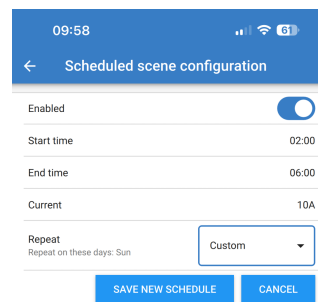
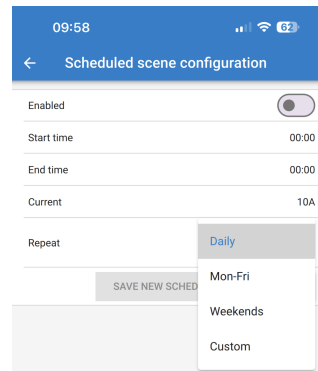
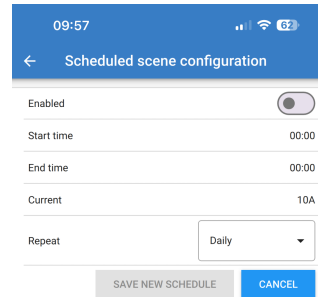
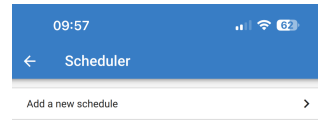

## 5.2.8. Light Ring

The light ring surrounding the charging cable socket on the front of the EV Charging Station NS shows what it is doing at a glance.

There are various lighting modes and brightness settings to choose from to represent the status of the EV Charging Station NS:

- Disconnected
- Connected
- Waiting for start
- Waiting for sun
- Low SOC
- Charging Manual
- Charging Auto
- Charged

### Light ring settings

The light ring of the EV Charging Station NS can be customised for each of its status modes as listed above.

- **Mode:** Choose the behaviour or pattern that the light ring displays:
  - Static
  - Blink
  - Breath
  - Color wipe
  - Color wipe inverse
  - Color wipe reverse
  - Color wipe reverse inverse
  - Color wipe random
- **Color:** Choose a color from the color picker or enter specific RGB values.
- **Period:** Specify how long the mode will be displayed for.
- **Brightness:** Adjust the brightness of LED ring for this mode, 0 - 100%.
- **Try this scene:** Tap the "TRY" button to test if the scene's color and brightness are suitable.

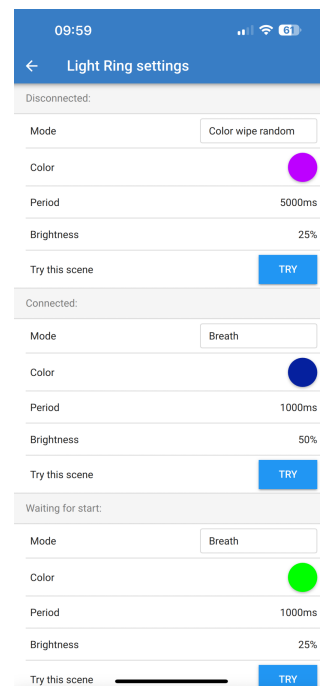

## 5.2.9. Access

### Web access credentials

The Web access credentials page allows you to change the access credentials for the web page of the EV Charging Station NS.

For security reasons it is strongly advised to change these credentials from their defaults.

- **User:** User name
- **Password:** Set a suitably strong password to prevent unauthorised access to the EV Charging Station NS.

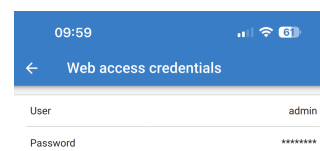

### 5.2.10. Reset to defaults

It is possible to factory reset the EV Charging Station NS via VictronConnect. Note that this process will reset **all** settings to their default values and require the first setup (see the [Setup \[8\]](#) chapter for details) to be performed again.

To get to the Reset to defaults option, tap the 3 vertical dots icon from the Settings page and tap on "Reset to defaults".

A "Restore device?" confirmation popup will appear. Tap "YES" to continue with restoring the device to factory defaults.

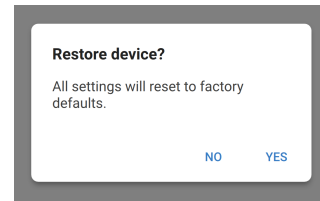

## 5.3. GX device setup, configuration and operation

### 5.3.1. Modbus TCP activation

The EV Charging Station NS communicates with the GX device via Modbus TCP. This must first be activated in the GX device and is a mandatory step.

In the GX device, go to Settings → Services → Modbus TCP and enable Modbus TCP.

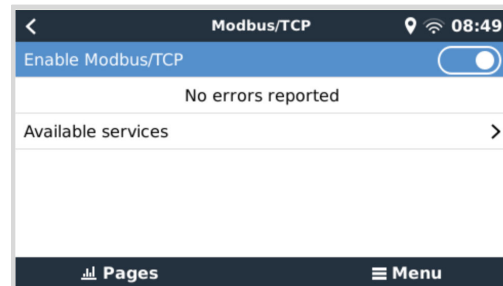

#### Activate the charging station in the Modbus TCP/UDP menu

This step is only required if it is an EV Charging Station NS that has not already been connected to the GX device **AND** the GX device has firmware version 3.12 or higher.

For devices that were already connected to the GX device before a GX firmware update to Venus OS 3.12, this step is not necessary. These units are activated automatically.

In the GX device, go to Settings → Modbus TCP/UDP → Discovered devices and activate the EVCS.

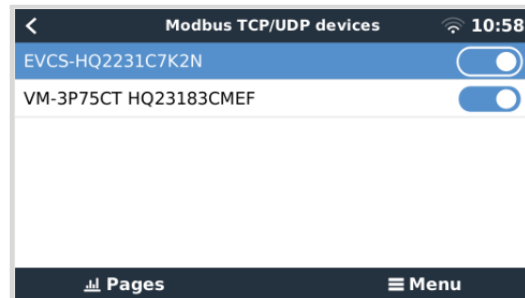

### 5.3.2. Setup menu and options

As soon as Modbus TCP has been activated, the EVCS appears in the device list and displays the current mode and charging state.

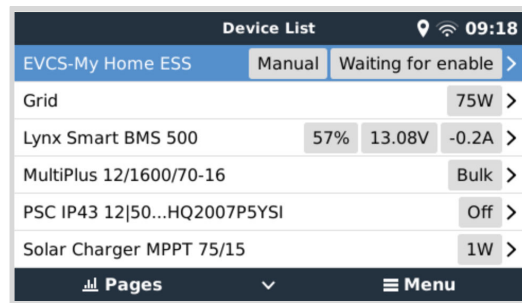

Highlight the EVCS then press spacebar or cursor right to enter the next menu and at the setup menu item press spacebar again to enter the setup menu. See the [EV Charging Station setup \[37\]](#) and the [Description \[2\]](#) chapter for the meaning of the available options.

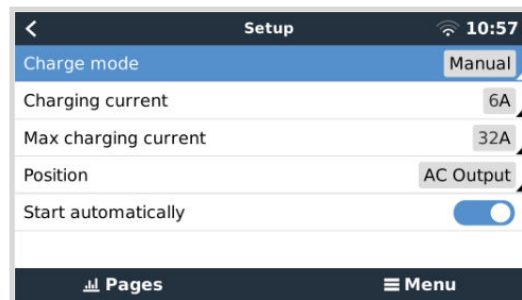

### 5.3.3. Overview and device menu

The overview menu provides a button to activate (start) charging in manual mode and the following status information:

**Actual charging current:** The charging current in A

**Total power:** Total power of all phases

**L1..L3:** Power of each individual phase

**Charging time:** The charging time per session

**Charged energy:** Charged energy per session

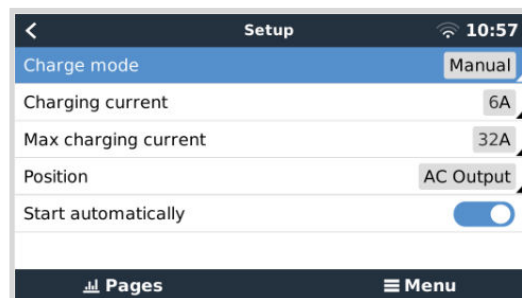

If you scroll further down the menu, you will see the Setup and Device menu. See the [Setup menu and options \[21\]](#) chapter for details.

The last menu item is the Device menu, which provides additional device information such as the connection type, product ID, VRM instance, firmware version and serial number. It is also possible to assign a custom name to the EVCS.

## 5.4. Firmware updates

The EVCS firmware can be updated manually via the web interface or remotely via [VRM: Remote firmware update](#).

The easiest way to update the EVCS firmware is through the VRM's Remote Firmware Update feature. You can perform the update automatically with a single button press or manually if preferred. Follow these [step-by-step instructions](#) to learn exactly how to do this. Please note that this requires a GX device connected to the VRM portal.

To update the firmware manually via the web interface, follow the steps below:

1. Download the latest firmware release from [Victron Professional](#)

Make sure you have the correct firmware file. For the EVCS model with a display, select the firmware file that contains "C025" in the file name. For the EVCS NS model, select the firmware file that contains "C026" in the file name.

2. Open the web interface
3. Click the Backup & FW tab

4. Click the Open button and browse to the location where the provided firmware file is stored.
5. Select the firmware file (\*.evcsup)
6. Click Update to start the update process

After a successful update, the charging station will restart, and the main page will be displayed again. All previous settings will be retained.

## 5.5. Reset to factory defaults and password recovery



Reset to factory defaults will reset **all** system settings to default values. The [First setup \[24\]](#) must then be carried out again.

This can be avoided by performing a partial reset, which will reset only the Bluetooth PIN code and the admin password. However, this option is only available via the DEF button method.

In case the password is lost, the initial password can be recovered in different ways:

### Reset to factory defaults from the web interface:

1. Click on the Settings button.
2. Click on the Backup & FW button.
3. Click on Reset to factory defaults.
4. Run the [First setup \[24\]](#) again.

### Reset to factory defaults via VictronConnect:

1. Open VictronConnect and tap on the EVCS from the My devices list.
2. Tap the cog wheel icon in the top right on the Status screen.
3. Tap the three vertical dots icon on the Settings page and choose Reset to defaults.
4. A warning will appear that **all** settings will be reset to factory defaults. Tap YES to reset to factory defaults.
5. Run the [First setup \[24\]](#) again.

### Partial and full reset to factory defaults using the DEF button inside the device:



**The procedure described below should only be performed by qualified personnel as this process requires the EV Charging Station NS to be powered. Working under high voltage is very dangerous and can be fatal if used incorrectly.**

#### • Partial reset

A partial reset only resets the admin password and Bluetooth PIN code, all other settings are preserved.

1. Open the unit by removing the backing plate. **Be careful not to touch the high-power parts inside the unit.** Only the area around the DEF button is safe.
2. For a partial reset, press the DEF button (see the image in [EV Charging Station setup web interface \[37\]](#) for its location) for more than 5 seconds but less than 15 seconds.

After releasing the DEF button, the RGB light ring starts blinking green rapidly to indicate that the partial reset is in progress.

Note that if your mobile device was successfully paired before resetting the PIN code, it is still possible to connect to the EVCS via VictronConnect as long as it is not unpaired. All other devices must be paired with the default PIN code as described in the VictronConnect [Setup, configuration & operation \[8\]](#) section.

If you were logged in to the web interface using a browser prior to the partial reset, the admin password reset for that connection will not take effect until you log out of the web interface. All other devices require the default password printed on the sticker inside the device. until a new password has been assigned; see [Access menu \[42\]](#) for details.

3. Mount the backing plate onto the device and tighten the screws.
4. Assign a new admin password; see [Access menu \[42\]](#) for details.

#### • Full reset

1. Open the unit by removing the backing plate. **Be careful not to touch the high-power parts inside the unit.** Only the area around the DEF button is safe.
2. For a full reset, press the DEF button (see the image in [EV Charging Station setup web interface \[37\]](#) for its location) for more than 15 seconds until the RGB light ring starts blinking blue rapidly to indicate that the full reset is in progress, then release the button.
3. Mount the backing plate onto the device and tighten the screws.
4. Run the [First setup \[24\]](#) again.

## 5.6. Maintenance

The EV Charging Station NS does not require specific maintenance.

## 5.7. First setup

## 6. Troubleshooting

### 6.1. CP Line Calibration



Starting with firmware v2.02, CP calibration is performed automatically every time an EV is connected to the EVCS. The Calibration button is hidden in the VictronConnect application and the web interface. However, it is still possible to perform manual calibration if you experience issues with EV detection. To do this, set Modbus TCP register 5133 to 0 (see section 6.2.11, Q11). This disables automatic CP calibration and makes the Calibration button available for manual calibration.

#### What is CP?

CP is the control pilot signal (line) inside each Type2 charger connector. It is a bi-directional communication line that enables communication between the charging station and the EV. Among other things, the charging station informs the EV of the maximum charging current available. At the same time, the EV informs the charging station about its status, for example whether the EV is connected or whether it is currently charging.

#### Why is CP line calibration necessary?

Due to differences in cable length and manufacturer as well as deviations in the ratings of electronic components, the CP signal may show deviations. The CP calibration takes the signal deviation into account and adjusts the signal values to the required ranges.

#### When does the calibration of the CP line have to be carried out?

There are several reasons for a CP line calibration. The most important are:

- The EV is connected to the EVCS via the charging cable, but still reports a disconnected state
- The EV was disconnected from the EVCS but was not reported as disconnected.
- When charging the EV, the EVCS frequently switches between the 'charging' and 'charged' states
- The EVCS does not start charging after connecting the vehicle because it cannot detect the correct state after connection

#### How is a CP line calibration carried out?

Please see the note above for instructions on how to enable the manual calibration feature.

The CP calibration can be done via the web interface (Settings → General → Charger → CP calibration or via VictronConnect (Settings page). The procedure is as follows:

1. Press the calibration button
2. Connect the EV to the EVCS and then tap on Next in VictronConnect
3. Press the 'Vehicle is connected' button to confirm that the EV is indeed connected to the EVCS (or tap on Next in VictronConnect)
4. Wait until the EVCS has completed the calculation

Once the calibration is complete, a message is displayed indicating that the calibration was successful

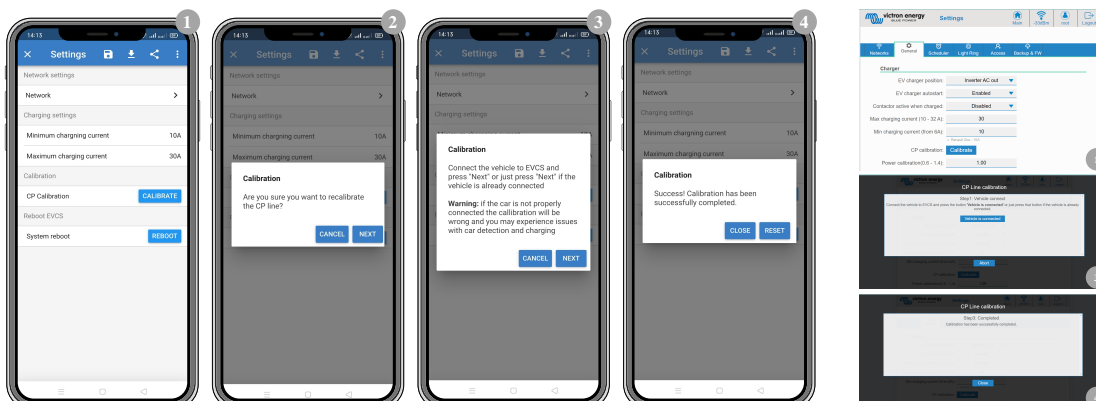

## 6.2. Frequently asked questions

### 6.2.1. Q1: How do I prevent the charging station from being used by unauthorised persons?

Make sure EV charger autostart is disabled in general settings. This prevents the charging station from starting to charge automatically once it is connected to an EV.

Charging can then only be started or stopped via the web interface, VRM App widget, VRM controls and VictronConnect.

### 6.2.2. Q2: Does the EV Charging Station have RFID?

No. To prevent the charging station from being used by unauthorised persons, see Q1.

### 6.2.3. Q3: The light ring is annoying my neighbours during night, how can I disable the light ring?

You can completely disable the light ring in the light ring menu, changing the brightness to 0 or a lower level if you like.

### 6.2.4. Q4: Why isn't my car recognized when I connect the charging cable?

Try calibrating the CP line (general tab in the web interface or in the VictronConnect settings). This is sometimes necessary because the charging cables can differ slightly. Ground impedance is also important as all measurements are relative to ground (GND).

Please see the note above for instructions on how to enable the manual calibration feature.

### 6.2.5. Q5: Why does my EV Charging Station show up on multiple GX devices?

If there are several GX devices on the same local network, activate the IP address whitelist in the General tab of the web interface and then add only the IP address of the GX device with which the EVCS is to be controlled to the whitelist. After doing this, remove the EVCS from the other GX devices.

### 6.2.6. Q6: How much PV power do I need at least to charge the EV in automatic mode?

The minimum current for charging an EV is 6A@230V. You therefore need more than 1.3kW of PV.

However, if there is not enough excess solar power available to meet the minimum charge current requirement, it is possible to enable the 'Allow low excess solar power for auto mode' option. This option supplements the required power with additional power from the grid to meet the minimum current requirement. See chapter [EV Charging Station setup web interface \[37\]](#) for details.

Example: To charge the EV at 6A while there is only 800W of excess solar power, 580W will be drawn from the grid to reach the required 1380W.

Note that there are EVs that require an even higher minimum charging current, e.g. the Renault Zoe; 10A.

### 6.2.7. Q7: Is it possible to operate multiple EV Charging Stations in one system?

Yes, this is possible. The available power is then shared between them.

### 6.2.8. Q8: The EV is fully charged, but the EVCS still alternates between start charging and stop charging, why?

The reason is most likely that the EVCS cannot correctly decode the 'charged' signal coming from the EV. Perform the [CP line calibration \[25\]](#) to remedy the problem.

Please see the note above for instructions on how to enable the manual calibration feature.

### 6.2.9. Q9: I keep getting a W-104 GX communication warning! What is the reason for this?

 **W-104: GX communication warning**

[Click here to open the manual](#)

This warning indicates that the EVCS cannot read data from the GX device due to a communication problem, even though communication with the GX device is enabled in the EVCS web interface.

To remedy the problem, make sure that the IP address specified in the general settings of the web interface matches that of the GX device. Use the Discover function to allow the EVCS to derive the correct IP address from the VRM Portal ID - for more details, see the [EV Charging Station setup \[37\]](#) chapter. Also make sure that [ModbusTCP is enabled \[20\]](#) in the GX device itself.

### 6.2.10. Q10: Is a GX device in the system absolutely necessary?

This depends on the operation mode.

For automatic mode, communication between a GX device and the EVCS is mandatory. For manual and scheduled mode, a GX device can be installed, but does not have to be.

### 6.2.11. Q11: I would like to control the EVCS via Modbus TCP. Is this possible and if so, how?

Yes, this is possible. Modbus TCP offers a much higher degree of flexibility and control and provides access to a broader range of settings than what is described in the manual or available through the normal user interfaces.



Note that changes to the settings via Modbus TCP will void any support.

The recommended method for support on Modbus-TCP questions is to use the [Modifications section on Victron Community](#). Its frequently visited by many people using Modbus TCP and other methods of integrating with Victron products.

The EVCS Modbus TCP register list can be downloaded from the [product page](#) in the download area.

## 6.3. EVCS Notification, Warning, Alarm and Error Codes

The table below lists all possible warnings, alarms and error codes displayed in VictronConnect, a GX device or the web interface, which can be used for quick diagnosis and help with troubleshooting.

### Errors

| VictronConnect code | GX device code | Generic code | Message                | Instructions/Remarks  |
|---------------------|----------------|--------------|------------------------|---|
| E-01                | #01            | 01           | GND not present        | Appears when the EVCS detects missing PE.<br>Contact the installer.   |
| E-02                | #02            | 02           | Welded contacts        | Appears when the EVCS detects welded contacts of the power relay.<br>Contact the installer.   |
| E-03                | #03            | 03           | CP input short-circuit | Appears when the EVCS detects CP input shorted.<br>Contact the installer.   |
| E-04                | #04            | 04           | Residual current       | Appears when the EVCS detects residual current.<br>Contact the installer.   |
| E-05                | #05            | 05           | Over temperature       | Appears when the EVCS detects overheating.<br>Remove EVCS from direct sunlight or contact the installer.  |
| E-06                | #06            | 06           | Light sensor IC fault  | Appears when the EVCS can't communicate with the light sensor IC (applied only for the United Kingdom of Gr. Brit. and N. Ireland).<br>Contact installer. |

| VictronConnect code | GX device code | Generic code | Message         | Instructions/Remarks   |
|---------------------|----------------|--------------|-----------------|--|
| E-07                | #07            | 07           | Tamper detected | Appears when the EVCS detects tampering (applied only for the United Kingdom of Gr. Brit. and N. Ireland).<br>Contact installer. |

### Warnings

| VictronConnect code | GX device code | Generic code | Message   | Instructions/Remarks  |
|---------------------|----------------|--------------|---|---|
| W-101               | #101           | 101          | Initial setup not completed                                     | Appears when the initial setup is not finished.<br>Perform initial setup.   |
| W-102               | #102           | 102          | EVCS externally blocked by grid operator                        | Appears when EVCS is locked externally by the grid operator.<br>Contact your grid operator.   |
| W-103               | #103           | 103          | EVCS high temperature detected                                  | Appears when a high temperature is detected in the EVCS box, but the temperature is not yet critical to stop charging.<br>Remove EVCS from direct sun light or contact installer. |
| W-104               | #104           | 104          | GX communication warning  | Appears when communication with GX is enabled but not present.<br>Check GX device IP address and VRM portal ID configuration.   |
| W-105               | #105           | 105          | Overload detected   | Appears when EVCS detects overload.   |
| W-106               | #106           | 106          | Overload active   | Appears when EVCS detects overload and it is active.  |
| W-107               | #107           | 107          | Scheduled mode failed - time sync issue                         | Appears when EVCS can't synchronise the local date/time and the user switches to scheduled mode.  |
| W-108               | #108           | 108          | The charging current is limited by an external switch           | Appears when EVCS is charging and the limit was activated by a special HW switch or over Modbus TCP. Currently only for Germany.  |
| W-109               | #109           | 109          | The charging current is limited due to inverter overtemperature | Appears when EV is charging and inverter reported overtemperature   |

### Notifications

| VictronConnect code | GX device code | Generic code | Message   | Instructions/Remarks  |
|---------------------|----------------|--------------|---|---|
| N-301               | #301           | 301          | Auto mode not available                             | Appears when attempting to set Auto mode but GX communication is disabled.<br>Enable communication with GX device.                        |
| N-302               | #302           | 302          | Scheduled mode not configured                       | Appears when trying to set Scheduled mode but the scheduler is not yet configured.<br>Add configuration for Scheduled mode.               |
| N-303               | #303           | 303          | Car disconnected - can't start charging             | Appears when the 'Start' button is pressed but the car is not connected to EVCS.<br>Connect the car.                                      |
| N-304               | #304           | 304          | Charger error                                       | Appears when the 'Start' button is pressed but the EVCS has an error.<br>Check errors and resolve them; contact the installer.            |
| N-305               | #305           | 305          | Initial setup not completed                         | Appears when the 'Start' button is pressed but the EVCS initial setup procedure is not finished yet.<br>Perform initial setup.            |
| N-306               | #306           | 306          | Charging will start according to scheduler settings | Appears when the 'Start' button is pressed but the EVCS is in Scheduled mode.<br>Switch mode to 'Manual' if you want to control charging. |
| N-307               | #307           | 307          | Overload active - can't start charging              | Appears when the 'Start' button is pressed but an overload is active.   |

## 7. Technical specification

| EV Charging Station NS                  |   |
|---|---|
| Input voltage range (V AC)              | 170 – 265VAC 50Hz   |
| Rated charge current                    | 32A / phase   |
| Nominal power                           | 22kW  |
| Current output range                    | 6 – 32A   |
| Wi-Fi standards                         | 802.11 b/g/n (2.4Ghz only)  |
| Self-consumption                        | 15mA@230V   |
| Configurable Max. Current               | 6-32A   |
| Configurable Min. Current               | 6-32A   |
| Connector type                          | IEC 62196 Type 2  |
| GENERAL                                 |   |
| Means to Disconnect                     | Depending on available input power and cable cross-section - max 40A  |
| Configurable price/kWh calculator (EUR) | Default setting: 0.13 (adjustable)  |
| Control type                            | Web page, GX device over Modbus TCP, VictronConnect via Bluetooth   |
| Light Ring                              | 55 configurable light effects available   |
| Protection                              | External RCD is required  |
| Operating temperature                   | -25°C to +50°C  |
| Storage temperature                     | -40 °C to +80 °C  |
| Humidity                                | 95%, non-condensing   |
| Data communication                      | ModbusTCP over WiFi, Bluetooth  |
| ENCLOSURE                               |   |
| Enclosure colour                        | Light Blue (RAL 5012), Traffic Black (RAL 9017), Traffic White (RAL 9016)   |
| Power terminals                         | 6-10 mm <sup>2</sup> / AWG 10-8   |
| Protection category                     | IP44  |
| Ventilation                             | not required  |
| Weight                                  | 3 kg  |
| Dimensions (h x w x d)                  | 372 x 292 x 122mm   |
| STANDARDS                               |   |
| Safety                                  | IEC 61851-1, IEC 61851-22<br>Detection for Relay Contact welded<br>Detection for missing protective conductor<br>Detection for missing Ground<br>Detection for shorted CP |

## 7.1. Dimensions

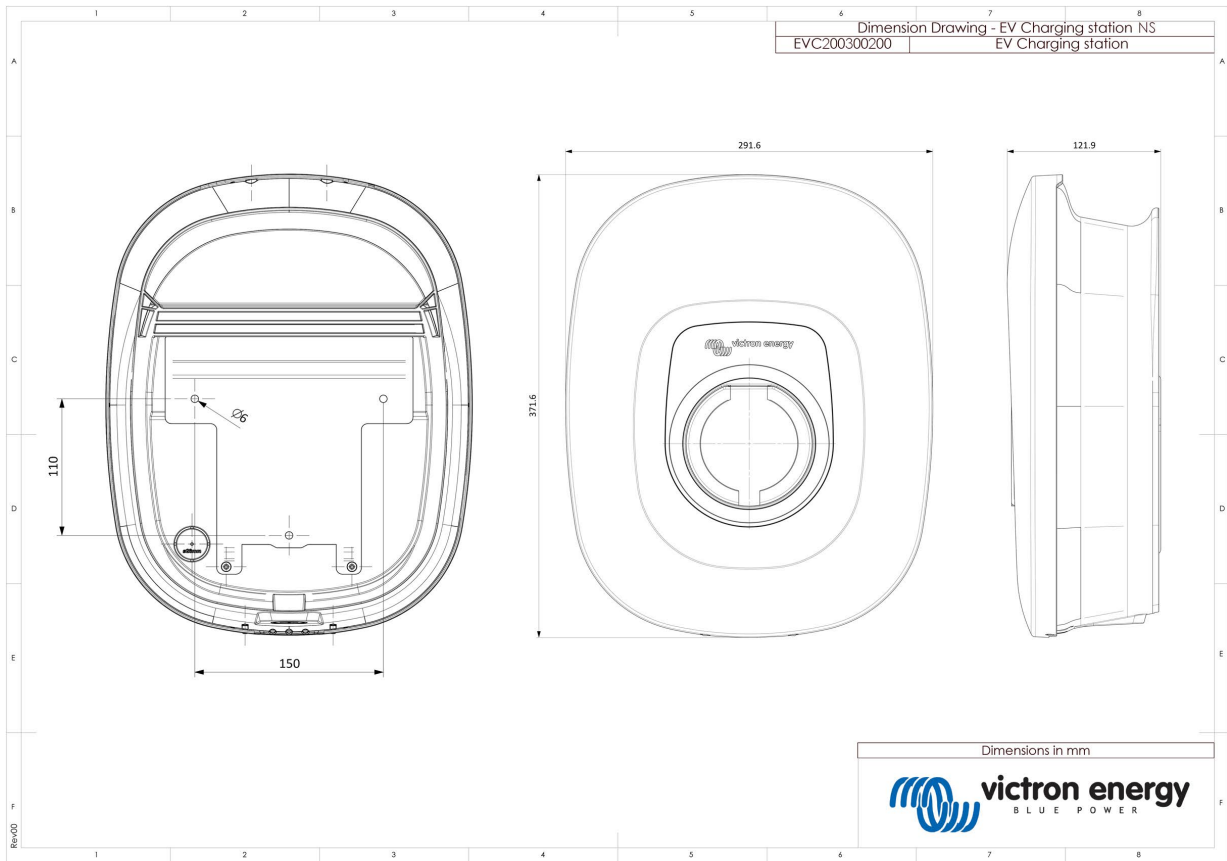

## 7.2. Drilling template

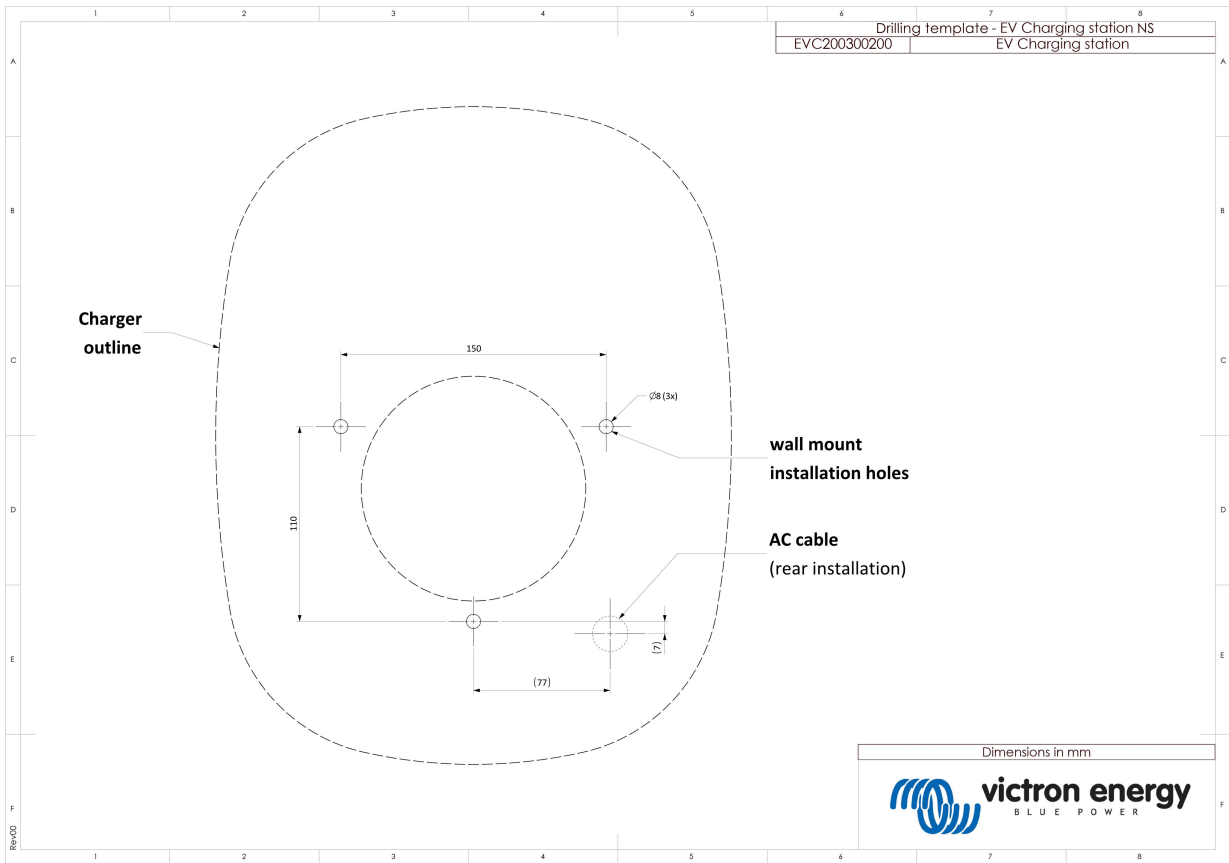

## 8. Appendix

### 8.1. First use setup and configuration via WiFi AP and web interface

The EVCS can also be set up and configured via the built-in WiFi AP (Access Point) and the web interface. The necessary steps are explained in the following sections.

#### 8.1.1. First use setup via WiFi access point

The charging station broadcasts its own WiFi access point as soon as the charging station is powered for the first time. The following steps describe the first setup to prepare the charging station for operation.

##### 1. Connect to the WiFi access point:

- I. Scan the QR Code on the internal label.
- II. Or go to the WiFi menu of your mobile device or laptop and manually add the access point that automatically broadcasts its SSID. SSID and Password are noted on a sticker inside the case.

Once connected to the access point, enter the default IP address 192.168.0.1 into a web browser. The default username is "admin". The default password is printed on the sticker inside the unit. The First setup process will then start:

##### 2. WiFi setup: Configure the WiFi network by choosing the WiFi mode

- I. **Access point:** The unit creates its own WiFi access point. This is either for setting up the unit or in the absence of a separate WiFi network including a GX device. Set SSID, IP address and Netmask according to your needs.
  1. Set SSID, IP address and Netmask according to your needs.

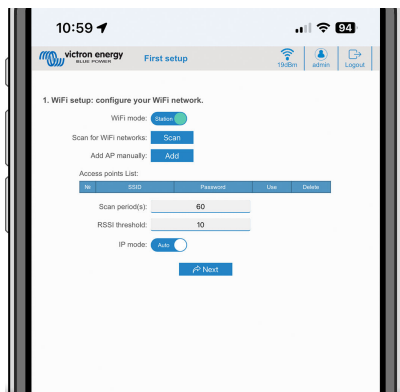

- II. **Station:** Connects the device to a local WiFi network that includes other Victron devices like a GX device or VRM.
  1. Change the WiFi mode from AP to Station.

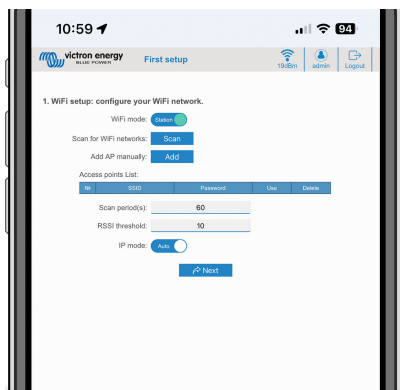

2. Click the Scan button (the scan period and RSSI threshold applies) to search for other WiFi networks or add manually a known AP by clicking the Add button. Note the WiFi standards: 802.11 b/g/n (2.4Ghz only).
3. Tick the network you wish to connect to and then click Apply.

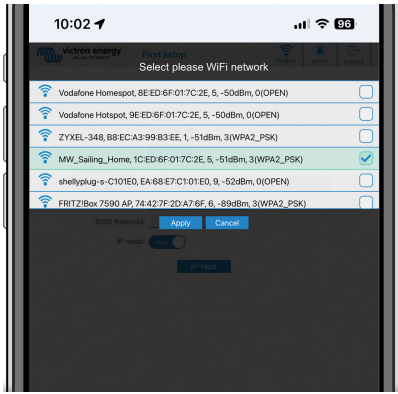

4. In the Password box, enter the external WiFi password and click Next.

In case you need a static IP rather than DHCP, change the IP mode button to Manual and fill in the static IP address, Mask, Gateway and DNS.



**3. Access setup:**

- I. Click into the Username field and type in your own username. The default username is 'admin'.
- II. Click into the Password field and change the password to a new one with at least 8 characters, containing lower, upper and special characters. The default password is printed on the sticker inside the unit.
- III. Confirm your new password.
- IV. Click Next.

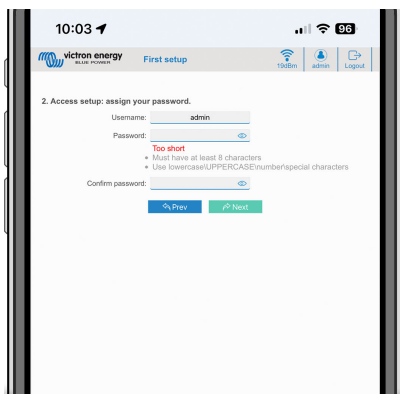

**4. Charging current setup:**

- I. Set the maximum charging current (6 - 32A).

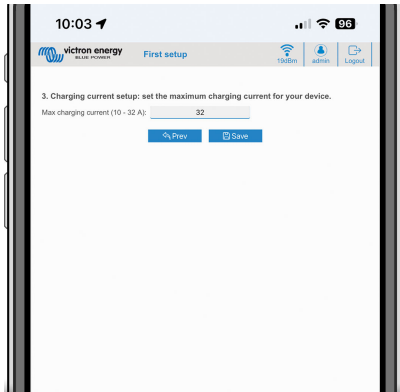

**5. Time zone setup and first setup completion:**

- I. Select the time zone region and set the time zone. Daylight saving time is processed automatically.

If UTC is selected as the region, it is necessary to enter the correct offset. Valid time format: +hh:mm or -hh:mm - Example: +02:00 or -01:00

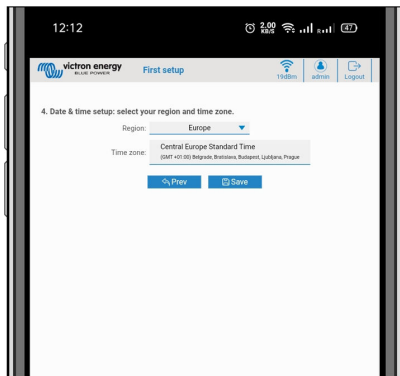

- II. Click Save to apply all settings. The system restarts and the login page of the web interface is displayed.

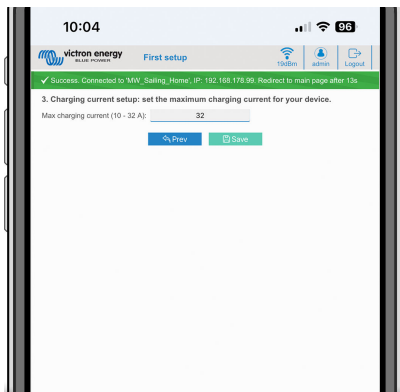

- III. Log in with your credentials that you entered under 3.

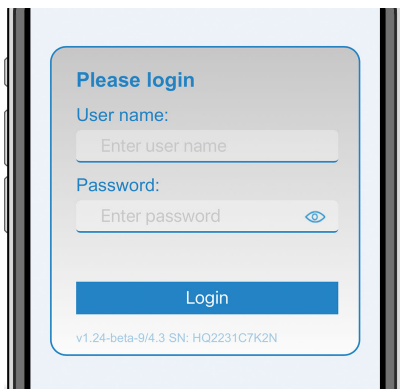

IV. The main page is then displayed and the EV Charging Station NS is ready for use.

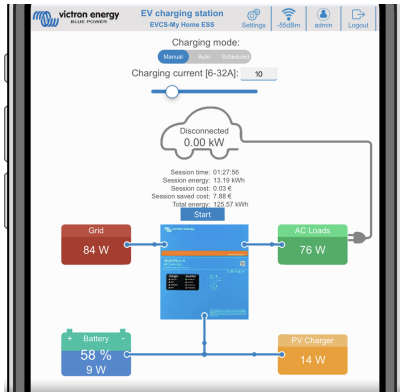

## 8.1.2. EV Charging Station setup web interface

After initial setup, set up the EVCS according to your needs. To do this, connect to the web interface and click on the Settings tab for further setting options. The main page options are explained in [The main page \[40\]](#) chapter.

Six subtabs will appear:

1. **Networks** tab: See the [Networks menu \[41\]](#) chapter.
2. **General** tab: Provides setting options for the charger, GX device communication, display, time zone and device name.
  - a. **Charger**: Charger related settings.
    - i. **EV charger position**: Select where the EVCS is positioned in the system. Examples:
      1. If the charging station is on the output of an inverter as one of the main's AC outsources, select Inverter AC out.
      2. If connected to the grid and the EVCS is positioned at the AC input of the grid before the inverter, select Inverter AC in.
    - ii. **EV charger autostart**: If this option is enabled, the EVCS will attempt to start charging after the vehicle is connected.
    - iii. **Contactor active when charged**: Keeps the contactor closed after charging. If, for example, an air conditioner is active in the vehicle, it is powered by AC power and not by the car battery.
    - iv. **Maximum charging current**: 6 - 32A
    - v. **Minimum charging current**: 6 - 32A. Example: A Renault Zoe needs at least 10A.
    - vi. **Power calibration(0.6 - 1.4)**: If the displayed power value is not correct, a maximum correction factor of +/- 40% can be applied.
    - vii. **Actual power (kW)**: Displays the current power value with which the EV is charged.
  - b. **GX device**: The EV Charging Station NS can be used:
    - i. As a stand alone device in Manual or Scheduled mode. Note that Auto mode requires a GX device and communication between the GX device and EVCS must be enabled.
    - ii. As part of a larger Victron Energy system. When enabling GX device communication, Modbus TCP must be enabled in the GX device (see [Modbus TCP activation \[20\]](#) section) itself to enable communication with the EVCS.  
To avoid errors, the easiest way is to have the pairing between the EVCS and the GX device performed automatically. With the Discover function, the EVCS is able to automatically detect the IP address via the VRM Portal ID.
      - A. **Communication**: Enable or disable communication with a GX device.
      - B. **IP address**: The IP address of your GX device. This will be automatically filled in when you use the Discover feature to pair the EVCS with the GX device.
      - C. **VRM Portal ID**: The VRM Portal ID of your GX device. This will be automatically filled in when you use the Discover feature to pair the EVCS with the GX device.
      - D. **Discover**: Click the Discover button to search for the GX device and pair the EVCS with the GX device. Select the GX device from the list that will pop up; the GX IP address and VRM Portal ID will then be entered automatically.
      - E. **Check**: Press this button to check communication with the GX device. The result is displayed at the top of the page.
      - F. **Start charging at backup battery SoC(%)**: The minimum backup battery SoC required to start charging in Auto mode.
      - G. **Stop charging at backup battery SoC, if off-grid(%)**: Stops charging when the backup battery SoC falls below this value and there is no grid.
      - H. **Allow battery/grid power for auto mode**: When enabled, auto mode will continue to charge at minimum current when there is insufficient excess solar power. Power is supplied from the grid or battery. This feature is useful to reduce the number of auto-charge enable/disable cycles while charging in auto mode.  
Note that EVCS cannot decide where to get power from (grid or battery), it's up to the inverter.
      - I. **Allow low excess solar power for auto mode**: Allows the EV to be charged with excess solar power plus power from the grid when the excess solar power is not enough to meet the minimum power requirement (6 A, 1380 W). Example: To charge the EV at 6A while there is only 800W of excess solar power, 580W will be drawn from the grid to reach the required 1380W.

- J. **Battery/grid power timeout(min):** The maximum timeout to stop drawing current from the battery/grid. This parameter relates to 'Allow battery/grid power for auto mode'.
- K. **Overload protection:** The EVCS reads the overload statuses from the inverter. When the inverter reports an overload, the EVCS reduces the charging current to the minimum value and waits about 5 seconds. If the overload is still active, the EVCS will stop charging and will not continue until the overload status is no longer present + some timeout.
- If the EVCS detects multiple overload situations within a certain period of time, the charging current will be reduced by 10%.
- The same applies to off-grid and grid-tied systems. For grid-tied systems, there is also an "input current limit", and the EVCS will work in the same way as described above if this limit is exceeded.
- A warning is displayed on the web interface or in Victron Connect when charging power is reduced or charging is interrupted.
- L. **Input current limit(A):** In the case of a grid-tied system, it displays the input current limit setting from the inverter, which serves as a threshold for 'Overload protection'.
- M. **Backup battery emulation:** If the system does not have a backup battery, enabling this option will emulate battery data on the EVCS side. This emulation allows charging to function in automatic mode, as battery data is required.
- c. **EVCS ModbusTCP Server:**  
EVCS ModbusTCP server. The address is the same as that of the GX device.
- i. **IP address whitelist state:** Enable or disable the whitelist state.  
Note that when the IP address whitelist state is enabled, only the devices from the IP address whitelist table below can communicate with the EVCS.
- ii. **IP address whitelist table:** Add IP addresses that are allowed to communicate with the EVCS.
- d. **Date & Time:**
- i. **Region:** Select your time zone region.
- ii. **Time zone/Offset:** Select the time zone. If UTC is selected, it is necessary to enter the correct offset.  
Valid time format: +hh:mm or -hh:mm - Example: +02:00 or -01:00  
Daylight saving time is processed automatically.
- e. **Others:**
- i. **Energy price per kWh:** Enter the cost per kWh to calculate the session cost saved.
- ii. **Device name:** Change the name of the EV Charging Station NS, which will then also be updated in the GX device, VictronConnect and the VRM portal.
3. **Scheduler tab:** The schedule required for the scheduled mode is created in this menu.  
You can schedule scenes to activate automatically under certain conditions. These conditions include:
- a. **Start time:** Start time of the schedule in hh:mm (24h time format applies)
- b. **End time:** End time of the schedule in hh:mm (24h time format applies)
- c. **Current[6-32A]:** Maximum charging current while the schedule is active
- d. **Repeat:** The time interval at which the schedule is automatically executed again. Possible options:
- i. **Daily:** Repeats daily
- ii. **Mon-Fri:** Repeated from Monday to Friday
- iii. **Weekends:** Repeats every weekend
- iv. **Custom:** Choose the days of the week you want the scene to repeat
- e. **State:** State of the scene. If disabled, the schedule for the scene will not run.
- Once a scene has been created, press the Accept button and then the Save button. Note that the scenes are only active when the charging station is in scheduled mode. A currently active scene is highlighted in green in the scheduler and marked active. Scenes can be edited at any time. The same rules apply as described above.  
Use the import and export buttons to import/export scenes in .json format.
4. **Light Ring tab:** Customises the ring of lights on the front of the station, around the vehicle socket. A variety of modes to choose from, how long the mode is displayed, the brightness of the lights and their colour.

The coloured ring is to indicate at a glance what the EV Charging Station NS is doing: for example, when the vehicle is fully charged, when there is a low state of charge.

Click the Save button at the bottom of the screen after any change or import/export the Light Ring settings in .json format.

5. **Access** tab: Change the username and password.
6. **Backup & FW** tab: Export or import saved settings, reset the charging station back to factory defaults and update firmware manually.
  - a. **FW Update:** The EVCS firmware can be updated manually via the web interface or remotely via [VRM: Remote firmware update](#).
    - i. **Select firmware file (\*.evcsup):** Press the Open button and browse to the location where the provided firmware file is stored, then click Update. This will start the update process. After a successful update, the charging station restarts and the main page is then displayed again. Note that all settings are retained.
  - b. **Backup:** Backup and restore all system settings from/to a .json format file.
  - c. **Reset to factory defaults:** Resetting the device to default values can be done in different ways:
    - i. From the webpage by selecting the Backup & FW menu and then press “Reset to factory defaults” or
    - ii. From inside the unit, by pressing the DEF button for more than 15 seconds. See image below. Note that if the DEF button is pressed less than 15 seconds but more than 5 seconds, it will reset the password only.



**The DEF button procedure should only be performed by qualified personnel as this process requires the EV Charging Station NS to be powered. Working under high voltage is very dangerous and can be fatal if used incorrectly. Be sure to avoid touching parts in the area marked in red.**

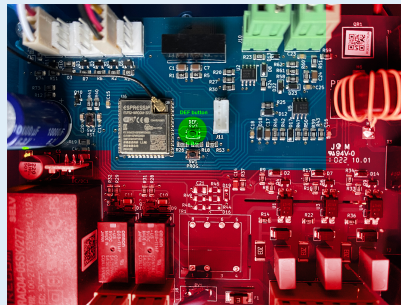

- iii. Via VictronConnect from the product info page.

### 8.1.3. The main page

The main page of the web interface provides control and monitoring elements for the EV Charging Station NS. These are from top to bottom:

- Charging mode switch: Change the charging mode to manual, auto or scheduled.
- Charging current slider: Adjust the charging current.
- Start/Stop button: Start or stop charging when in manual mode.

Note that after pressing the stop button, first the charging current is reduced to a minimum and only then the contactor opens (with a delay of 2 seconds).

- Session statistics and an animated graphical overview to see the charging progress at a glance.

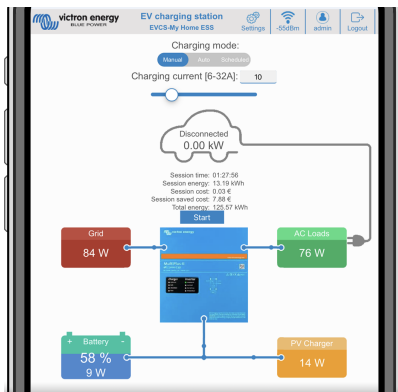

#### Charging mode switch in detail

The Charging mode switch is located on the main screen and provides three different operation modes:

- **Manual** mode: Enables the user to turn the vehicle charging ON and OFF manually, using the START STOP button. The amount of current the station provides, can be changed using the Charging current slider.
- **Automatic** mode: The system will determine all the settings for the user. Similar to a GX device, the screen shows how the current is flowing. A GX device such as the [Cerbo GX](#) or [Color Control GX](#) must be included in the system for this operation mode to work. There are a variety of settings that can be changed directly from the GX device related to either manual or automatic mode. One can see the device, its summary as well as more advanced power graphs on the main dashboard of the [VRM Portal](#).
- **Scheduled** mode: Charge the EV at certain time intervals, for example during the night hours when grid energy is cheaper.

The manual and automatic modes ensure the best use of the charging station.

The charging mode can be changed via:

- The main web page
- A GX device
- The VRM Portal (requires a GX device in the system)
- Bluetooth and VictronConnect.

The manual mode gives flexibility in choice and charges the car independently of PV production. By manually determining how much power goes into a vehicle charge, you can make allowances for other loads in your home.

The automatic mode ensures maximum efficiency of the PV system and charges excess PV power to the EV before it is fed into the grid.

When the EV Charging Station NS is connected to a Victron system and is in automatic mode, the excess solar power can be used to charge the vehicle instead of, for example, feeding it into the grid at a lower price.

## 8.1.4. Networks menu

WiFi options and Bluetooth are configured via the network menu of the web interface. Available options are:

### 1. WiFi

- a. **WiFi mode:** Toggles between access point and station mode.
  - i. **Access point mode:** The unit creates its own WiFi access point. This is either for setting up the unit or in the absence of a separate WiFi network including a GX device. SSID, password, IP address and Netmask are configurable.
  - ii. **Station mode :** Connects the device to a WiFi network that includes other Victron devices like a GX device or VRM. To do this:
    - A. Change the WiFi mode from AP to Station.
    - B. Click the Scan button to manually search for other WiFi networks or manually add a known AP by clicking the Add button. Note the WiFi standards: 802.11 b/g/n (2.4Ghz only).
    - C. Tick the network you wish to connect to and then click Apply.
    - D. In the Password box enter the external WiFi password and click Next.
    - E. In case you need a static IP rather than DHCP, change the IP mode button to Manual and fill in the static IP address, Mask, Gateway and DNS.
    - F. Click Save. Note that when Station mode is enabled, a WiFi strength indicator appears at the top of the web page.

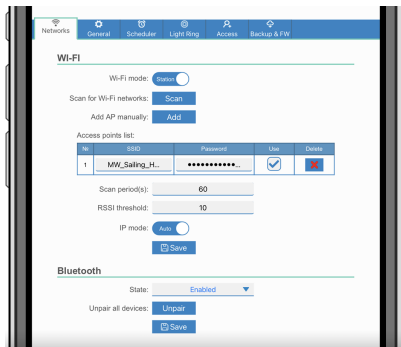

- iii. **Scan period:** If there is only one network to connect to (e.g. a router), the scan period can be set to 0 to avoid unnecessary scanning during an existing connection. If the EVCS connects to more than one network, it is recommended to leave it at the default (60). Note that this is about background network scanning. This parameter has no effect on the manual scan button.
- iv. **RSSI threshold:** An RSSI threshold can be applied to background scanning.

### 2. Bluetooth

Bluetooth establishes a direct wireless connection between a mobile device and the EV Charging Station NS to control and monitor the EVCS via [VictronConnect](#). The distance is usually a few meters indoors.

The pairing code can be changed via VictronConnect. A factory reset resets the pairing code to factory defaults.

To enable, disable or unpair Bluetooth via the network menu, the following options are available:

- a. **State:** Enables or disables Bluetooth functionality. A change requires pressing the Save button to apply the new status.
- b. **Unpair all devices:** Click to unpair the EVCS from your mobile device(s). Note that this will also restart the charging station and you will still need to remove the pairing from your mobile device's Bluetooth menu.

### 8.1.5. Access menu

In the Access menu you can choose your own username and password (strongly recommended). Note that you will be prompted to change the password during the initial setup.

To change the username and password:

1. Click into the Username field and type in your own username.  
The default username is 'admin' (without apostrophe).
2. Click into the Password field and change the password to a new one with at least 8 characters, containing lower, upper and special characters.  
The default password is printed on the sticker inside the unit.
3. Confirm your new password.
4. Click Next.

In case the password is lost, see the [Reset to factory defaults and password recovery \[23\]](#) chapter.

## 8.2. External control of grid-relevant power (§14a EnWG - Germany)

The charging current of the EVCS can be limited to a maximum of 6 A using an external switch. This is particularly relevant in Germany to comply with the requirements of §14a EnWG (applicable to charging stations installed from 1 January 2024) and to enable the grid operator to reduce the charging power to help maintain grid stability. Note that this feature requires EVCS firmware v2.0 or later.

A warning (W-108 – The charging current is limited by an external switch) will appear on the display, web interface, or in VictronConnect when the switch is activated.

The diagram below shows how such a switch or relay should be wired to the EVCS.

